

Velo

FontanaArte

COMPANY:

PROJECT:

DATE:

PRODUCT NAME: Velo

CODE NUMBER: 2805/1

COLLECTION: FontanaArte

TYPE: Wall

DESIGNER: Franco Raggi

PRODUCTION YEAR: 1989

Wall lamp. Frame with lamp holder and reflector in polished aluminium. Diffuser in tempered, sandblasted, curved glass, 3 mm thick. Halogen bulb protective shields in sandblasted pirex glass.

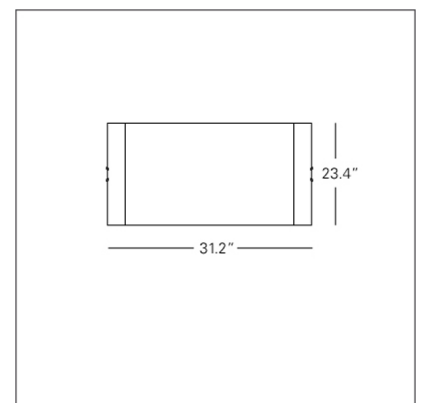

Light source: 1x200W T3/L Double Ended R7s - long (HA)



FontanaArte spa reserves the right to make changes on this document and on the products here described without any prior notice.

Copyright © 2008 FontanaArte spa. All rights reserved.

It is forbidden to modify the present document, even partially, without a prior written authorisation by FontanaArte spa.