

# NEW WORKS.

Product Fact Sheet - Furniture - Covent Bar Stool 75



## Covent bar Stool 75

*Arde Design Studio*

While the other members of the Covent family balance the elements; the Covent Lounge Chair and Covent Sofa present a universe of warmth. The soft organic top of the Covent Chair has been extended to the ground, the bold frame replaced with the soft touch of an upholstered base and generous seating cushion. Showcasing the expert detailing and craftsmanship that comes with a range produced solely in Denmark, this pair invites you to nestle within and feel the tenderness of each upholstered surface.

### About the designer Arde Design Studio

The work of Arde Design Studio displays a paired back aesthetic and holistic approach to ideation and production. Since 2003 he has worked for some of the worlds leading industrial design and furniture companies, further refining his approach to design. This lead to Arde Design Studio establishing their own studio in 2014 with their work already featured in the collections of prominent companies throughout Europe and beyond.

Item No	Variation
41102	Kvadrat Remix 2 233 w. Black Frame
41100	Costumers Own Material (COM)
41101	Upholstery in Category A
41101	Upholstery in Category B
41101	Upholstery in Category C
41101	Upholstery in Category D
41101	Upholstery in Category E

# NEW WORKS.

Product Fact Sheet - Furniture - Covent Bar Stool 75

## Specifications

<b>Product Name</b>	Covent Bar Stool 75
<b>Designer</b>	<b>Arde Design Studio</b>
<b>Year</b>	2019
<b>Category</b>	Furniture
<b>Type</b>	Bar Stool
<b>Material</b>	Powder coated steel frame and seat in high quality foam with selected upholstery
<b>Product Dimensions</b>	H: 750 x W: 460 x D: 360 mm Seat Height: 750 mm
<b>Packaging Dimensions</b>	H: 795 x W: 492 x D: 392 mm
<b>COM</b>	Fabric Requirements 0,7 meter, Leather Requirements 0,5 meter
<b>Delivery time</b>	4 - 6 weeks
<b>County of origin</b>	Europe

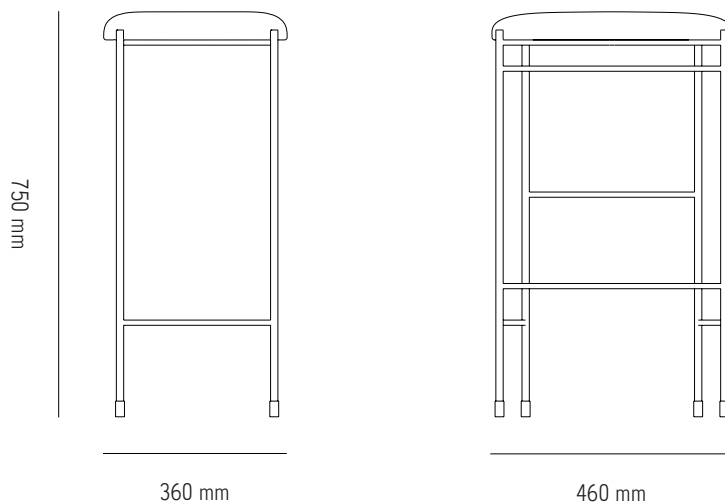

# NEW WORKS.

Product Fact Sheet - Furniture - Covent Bar Stool 75

## Price Categories - Standard Fabric/Leather

### Category A

Kvadrat - Floyd (FL), Merit (ME), Remix (RE)

### Category B

Kvadrat - Fjord 2 (FJ), Harald (HR), Molly 2 (MO), Re-Wool (RW)  
Sørensen Leather - Ultra (UL)

### Category C

Kvadrat - Divina Mel. 2 (DM), Hallingdal 65 (HA)  
Sørensen Leather - Shade (SH)

### Category D

Astrid - Mons (MS)  
Dedar - Karakorum (KA)  
Febrik - Sprinkles (SP), Uniform Melange (UM)  
Sørensen Leather - Icon (IC), Royal Nubuck (RN)

### Category E

Astrid - Baby Mohair (BM)  
Dedar - Alexander Melange (AM)  
Febrik - Gentle 2 (GE)  
Kvadrat - Byram (BY) Coda 2 (CO), Vidar 3 (VI)

## Frame Option

Iron Black (BL)  
Metallic White (WH)  
Raw Gold (RG)

## Guidance

To view the different fabric colour code/name please visit the fabric suppliers website, see physical color card or sample book. Color card or/and sample book can be ordered directly from the fabric supplier or from New Works (info@newworks.dk) against payment.

**Astrid** - [www.astrid.se](http://www.astrid.se)

**Dedar** - [www.dedar.com](http://www.dedar.com)

**Febrik** - [www.febrik.com](http://www.febrik.com)

**Kvadrat** - [www.kvadrat.com](http://www.kvadrat.com)

**Sørensen Leather** - [www.sorensenleather.com](http://www.sorensenleather.com)

## Cleaning & Care Guide

Visit our website at [www.newworks.dk/maintenance-care/](http://www.newworks.dk/maintenance-care/) for the cleaning and maintenance instructions for your chosen textile.

## Safety Precautions

Please read the instructions carefully and retain them for future reference. New Works Aps is not responsible for any faults or damages caused by not following the instructions correctly. Do not modify the product in any way. Keep your furniture out of direct sunlight. Colors will fade and seams will weaken when exposed to direct sunlight. The furniture is only intended for indoor use.