

Designer
Yaacov Kaufman - 2003

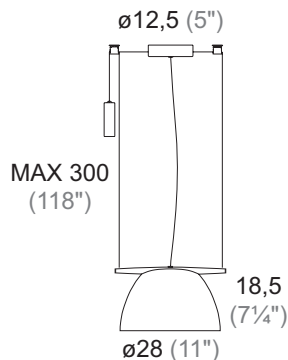

Sospensione in acciaio ed alluminio per illuminazione diretta verso il basso. L'apparecchio può essere fisso (cod. 620) o regolabile in altezza con un sistema di contrappesi (cod. 630) e cavi in poliestere nero.

Pendant downlight fitting made out of steel and aluminium for direct lighting. The suspensions can be fixed (code 620) or adjustable in height by means of a steel counterbalance (code 630) and a black polyester rope device.

Hängeleuchte aus Stahl und Aluminium für direkte Beleuchtung. Das Gerät kann fix (Kod. 620) oder höhenverstellbar sein (Kod. 630). Die Höhenverstellung erfolgt mittels einem Seilzug aus schwarzem Polyester mit Gegengewicht.



Col. 09
Nero raggrinzato
Black wrinkled
Schwarz schrumpflack



Col. 11
Bianco goffrato
Crackled white
Weiß aufgerauth





Col. 19
Grigio goffrato
Crackled grey
Grau aufgerauth



Col. 20
Policarbonato
Polycarbonate
Polikarbonat



Col. 37
Ramato arabescato
Copper arabesque
Kupfer arabesk

Denominazione - Name - Name	Omega 28 (cod. 620 - 630)
Certificazioni - Certificated - Prüfzeichen	
Normative - Norms - Normen	EN 60-598 (CEI 34-21)
Lampadina - Light sources - Leuchtmittel	MAX 100W I/HAL  - 24W FL EL - E27/E26
Versioni - Available - Versionen	230V (Europe) - 110V (USA - Japan) - 240V (England)
Classe di isolamento - Insulation Class - Isolierungsklasse	I
Classe di protezione - Protection Class - Protektionsgrad	IP20
Imballo - Packaging - Verpackung	 0,025m ³ - 2,400Kg (cod. 620) - 3,000Kg (cod. 630)

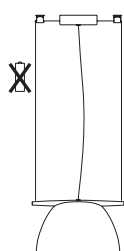

Cod. 620
Omega 28

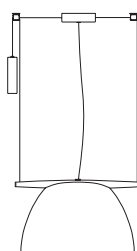

Cod. 640 - 650
Omega 42

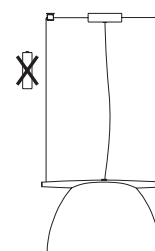

Cod. 641 - 642 - 643 - 644 - 645
Omega 42 FL

Actions

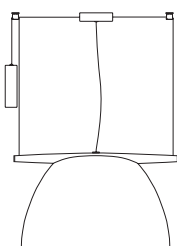

Cod. 660 - 670
Omega 56

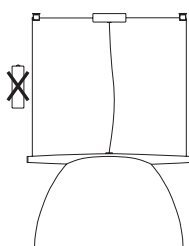

Cod. 661 - 662 - 663 - 664 - 665
Omega 56 FL

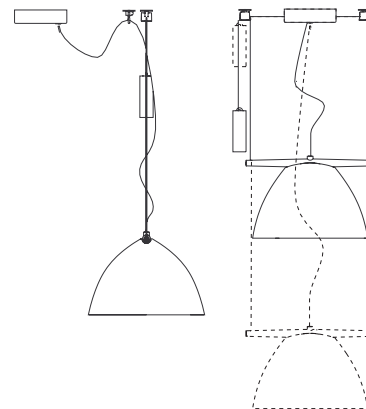

Notes
