

MATRIX Quattro

Designer

Yaacov Kaufman - 2000

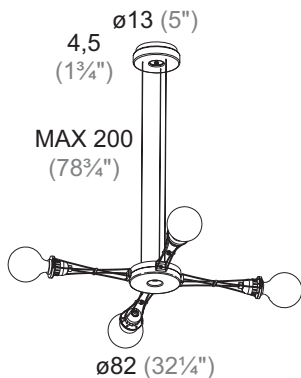

Sospensione costituita da un corpo centrale e da quattro bracci mobili in senso verticale. Possono essere montate anche, entro i limiti di potenza indicati, lampadine alogene o fluorescenti compatte elettroniche.

Hanging lamp in aluminium alloy and steel made out of a central body with four arms that can be moved vertically; halogen or fluorescent compact bulbs can be used within the maximum admitted power.

Hängeleuchte bestehend aus einem mittleren Körper und vier in Vertikal beweglichen Armen. Die Leuchte kann auch mit Halogen oder Leuchtstofflampen best,ckt werden.





Col. 01
Nero
Black
Schwarz



Col. 07
Grigio metallizzato
Metallic grey
Metallic grau



Col. 44
Nichelato
Nickled
Vernickelt

Denominazione - Name - Name	Matrix Quattro (cod. 386)
Certificazioni - Certificated - Prüfzeichen	
Normative - Norms - Normen	EN 60-598 (CEI 34-21)
Lampadina - Light sources - Leuchtmittel	4 x MAX 75W I/HAL - 21W FL EL - E27
Versioni - Available - Versionen	230V (Europe) - 110V (USA - Japan) - 240V (England)
Classe di isolamento - Insulation Class - Isolierungsklasse	I
Classe di protezione - Protection Class - Protektionsgrad	IP20
Imballo - Packaging - Verpackung	 0,057m ³ - 3,180Kg

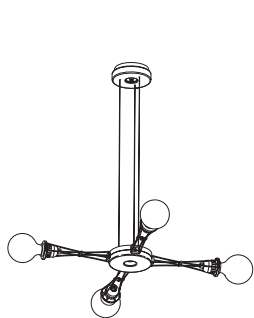

Cod. 386
Matrix Quattro

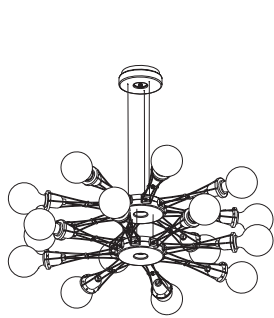

Cod. 387
Matrix Doppia

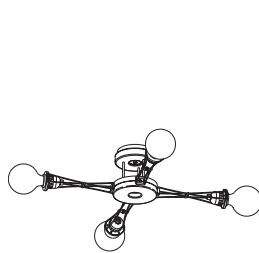

Cod. 388
Matrix Quattro/P

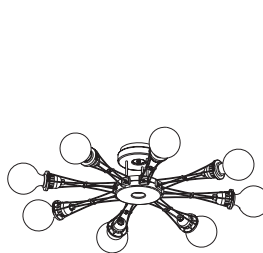

Cod. 389
Matrix Otto/P



Cod. 393 - 394
Matrix Terra

Actions

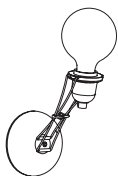

Cod. 395 - 396
Matrix Mono
Matrix Mono/I

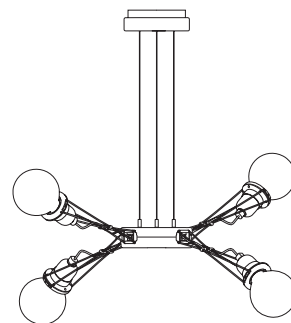
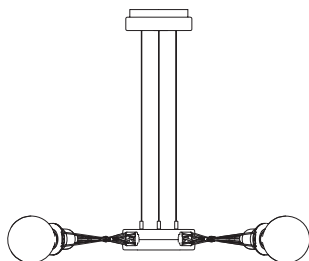

Notes
