

GALILEO

design Emanuele Ricci



Light performers



LUMINA
www.lumina.it







Diagramma ottico

Optical diagram
Optisches Diagramm

Supporto cristallo

Crystal support
Halter für Kristallglass

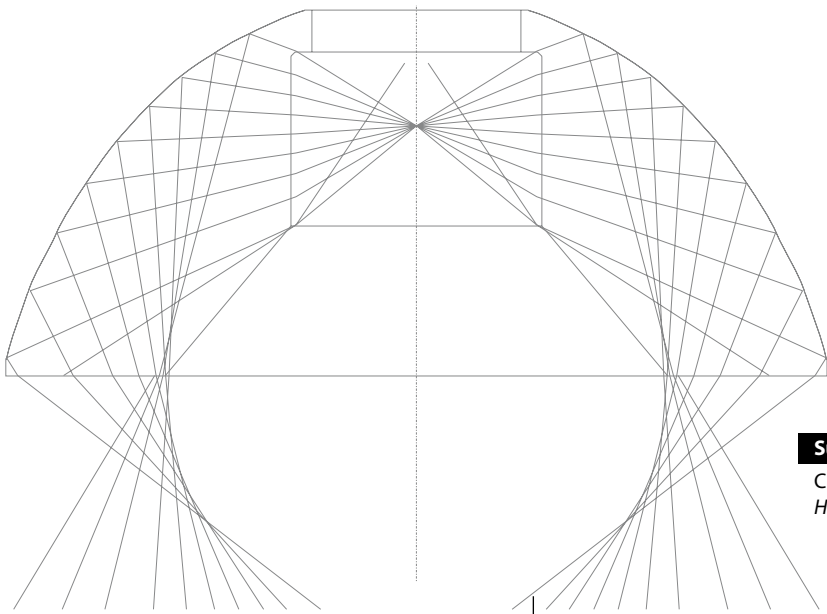
Pressofusione di alluminio

Die-cast aluminium
Pressgussaluminium

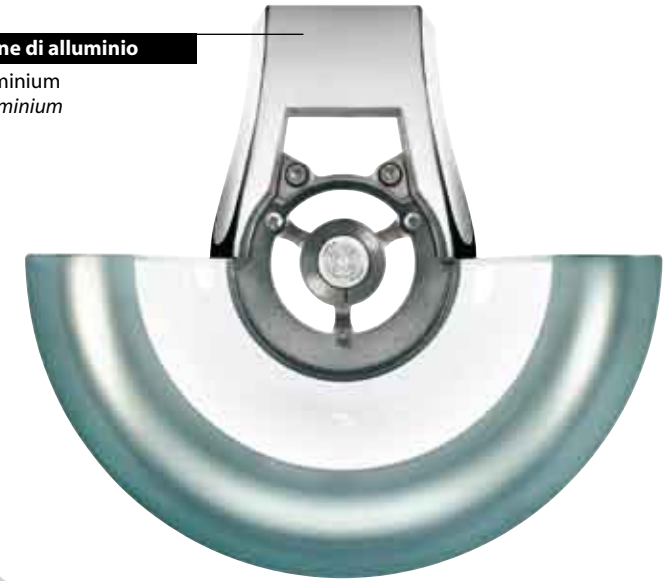

Sezione del vetro fresato

Section of the milled glass
Schnitt des gefrästen Glases



Lente in cristallo ottico

Optic glass lens
Optische Linse aus Kristallglas

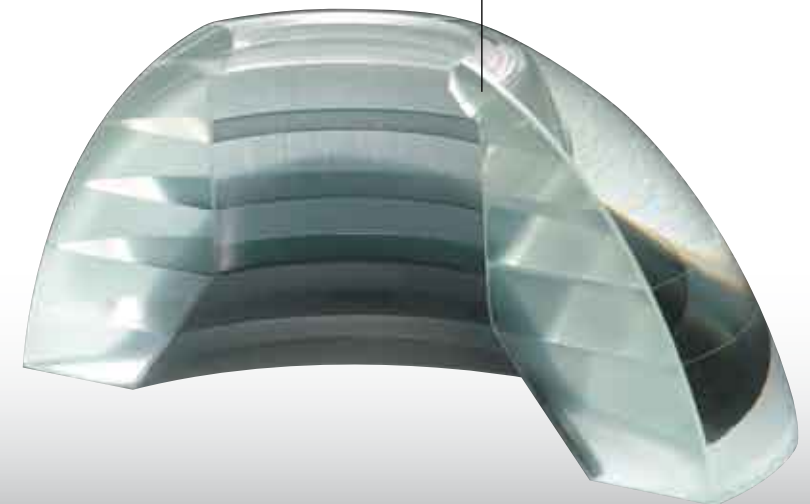



Attacco a binario 220V

220V-connection on track
Schieneanschluss 220V
 [Galileo - Galileo L]



Attacco a binario 12V

12V-connection on track
Schieneanschluss 12V
 [Galileo Mini]

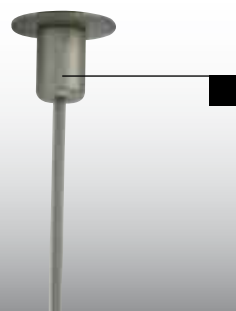

Attacco a 12V

12V-connection
Anschluss 12V
 [Galileo Mini]

IESNA files on www.lumina.it

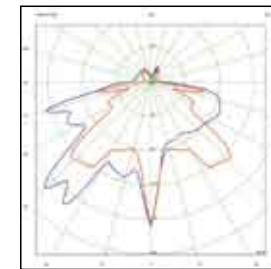
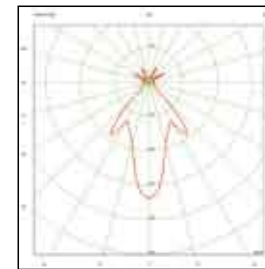
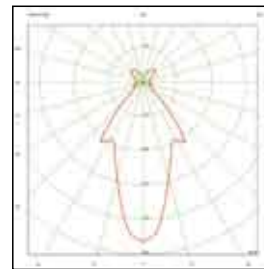

Serie di lampade con diffusore in cristallo lavorato con finiture ottiche che ha le funzioni di una lente curva di notevole spessore (circa 35mm).

A range of lamps with diff user made out of thick (approx. 35mm - 1 3/4") extrabright glass with optical qualities.

Produktfamilie für direktes und indirektes Licht durch ein Kristallglas mit optischen Feinbearbeitungen, das die Funktion einer sehr dicken (ca. 35mm) Konkavlinse hat.

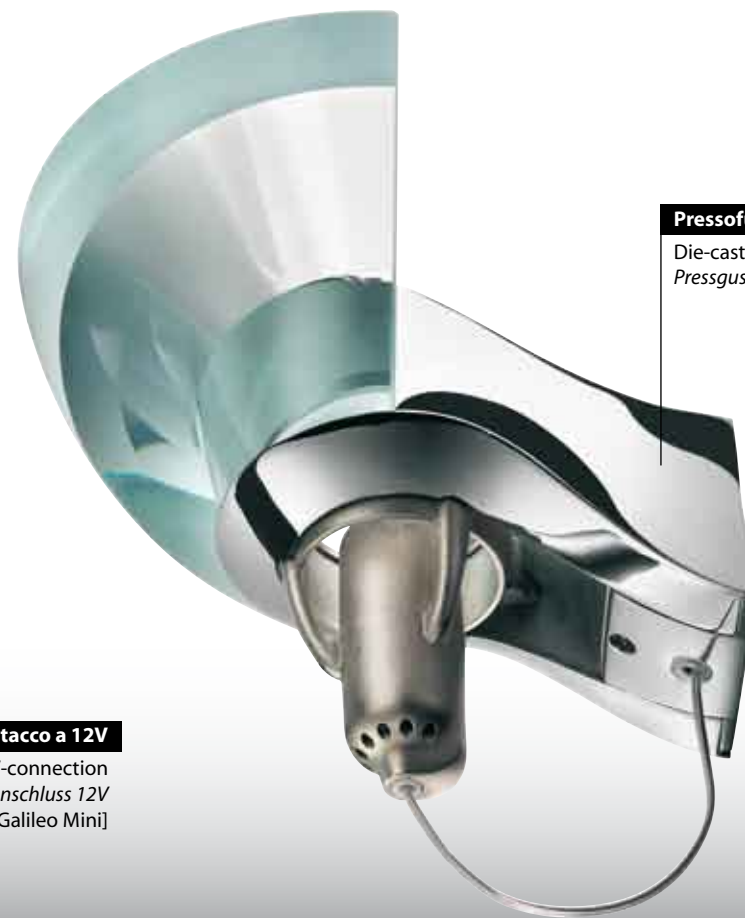

Pressofusione di alluminio

Die-cast aluminium
Pressgussaluminium

● Galileo Parete



● Galileo



● Galileo Mini

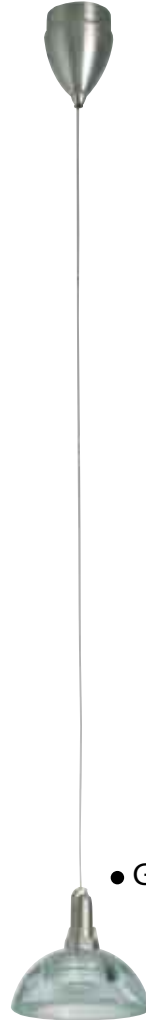

Color 44
Nichelato
Nickled
Vernickelt

● Galileo Mini 3

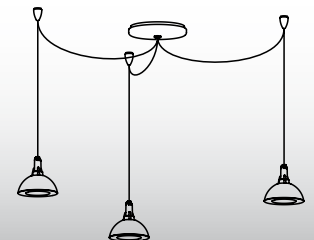
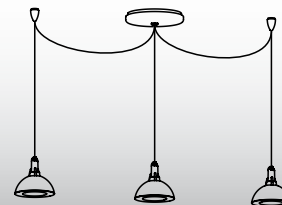
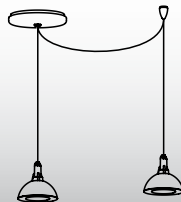
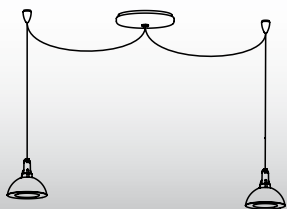

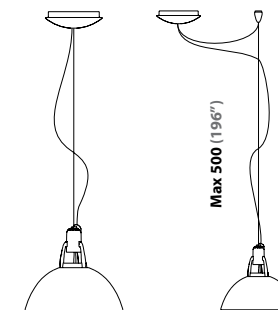
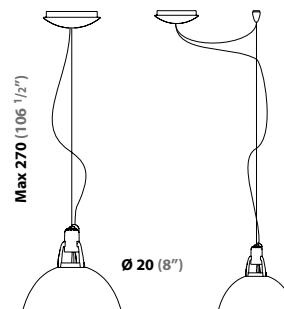
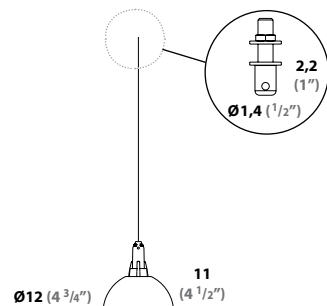
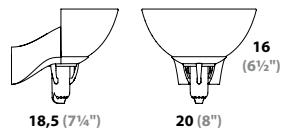

Galileo Parete

Cod. 378

Max 100W Hal • B15d



Galileo Mini Bs

Cod. 375

12V 50W Hal • GY6.35



senza trasformatore
without transformer
Ohne Trafo

Galileo

Cod. 380

Max 100W Hal • B15d



Galileo L

Cod. 381

Max 100W Hal • B15d

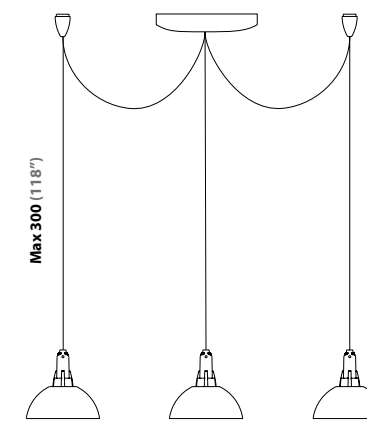
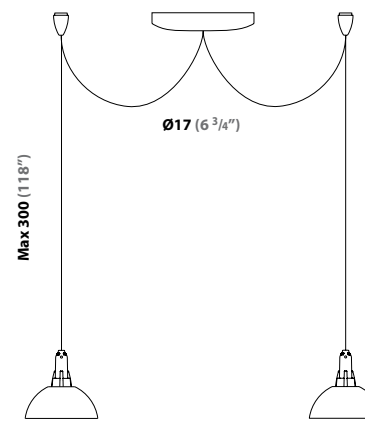
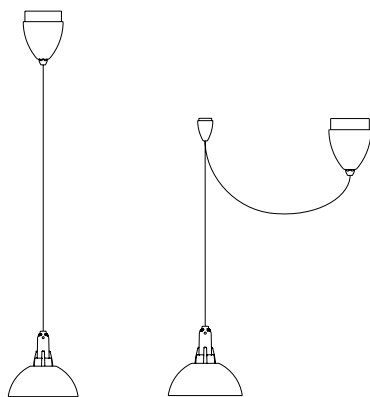
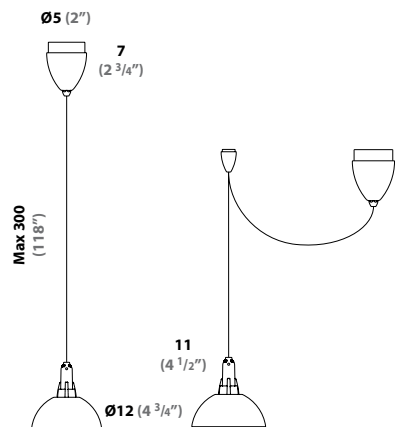

Galileo Mini T

Cod. 383

12V 50W Hal • GY6.35



con trasformatore
with transformer
Mit Trafo

Galileo Mini ST

Cod. 384

12V 50W Hal • GY6.35



senza trasformatore
without transformer
Ohne Trafo

Galileo Mini 2

Cod. 376

2 x 12V 50W Hal • GY6.35



con trasformatore
with transformer
Mit Trafo

Galileo Mini 3

Cod. 377

3 x 12V 50W Hal • GY6.35



con trasformatore
with transformer
Mit Trafo