

D40

starled light

alberto meda, paolo rizzato

LUCE
PLAN

table



D40/L

1 white LED
recharger kit included

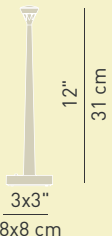

D40/R

1 white LED

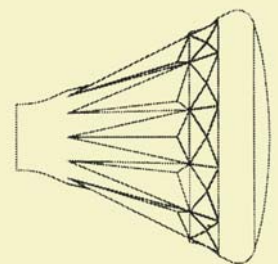
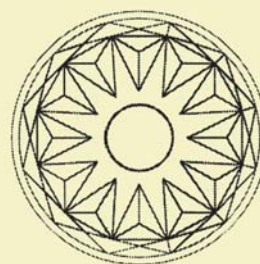
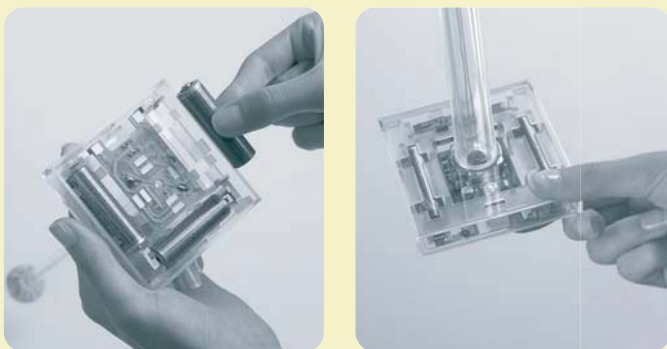



the lamp operates on 3 RECHARGEABLE AA size NiMH (Nickel Metal Hydride) for a life of about 4 hours

materials

methacrylate

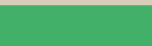
structure and head finishes

	+		+		+	
green		transparent		light blue		metal