

# Artemide®

## Tolomeo Pinza - Tolomeo Micro Pinza

design  
M. De Lucchi  
G. Fassina

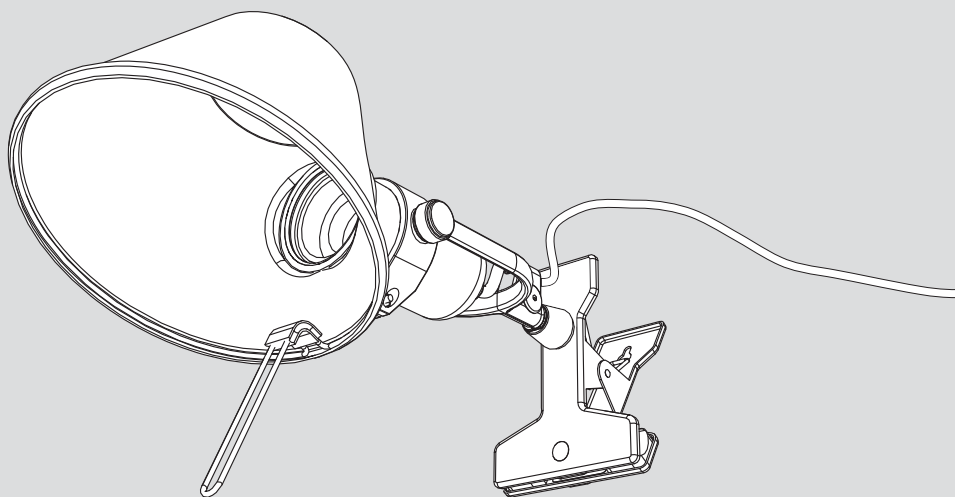



i

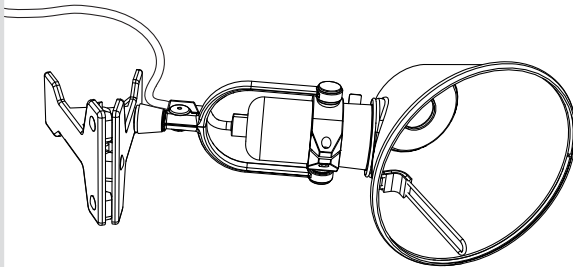
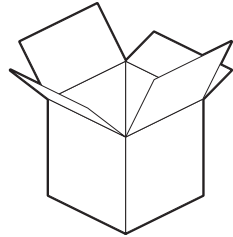
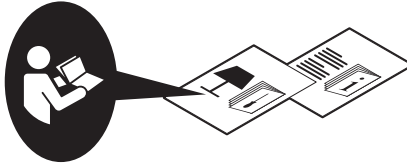
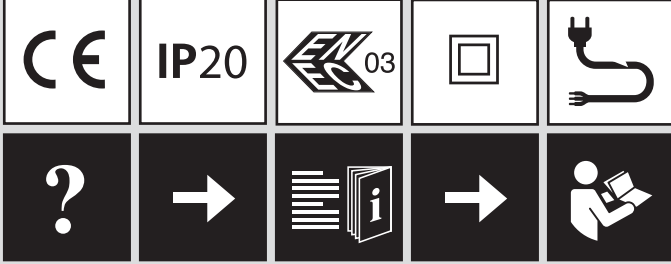

1

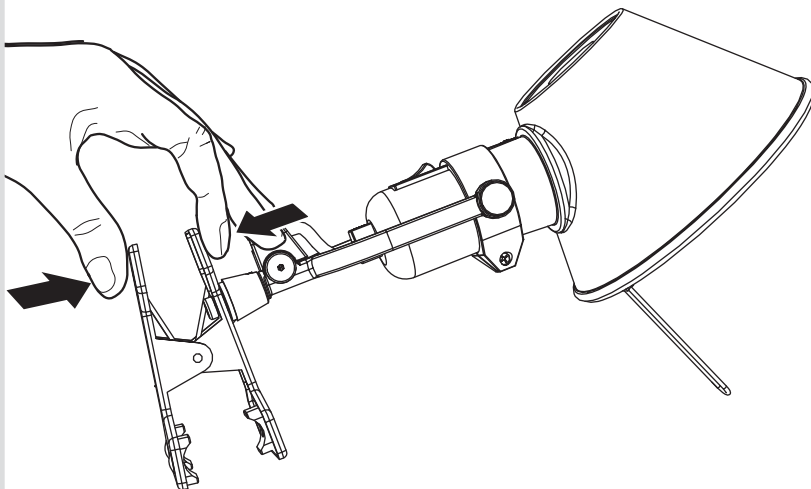

2

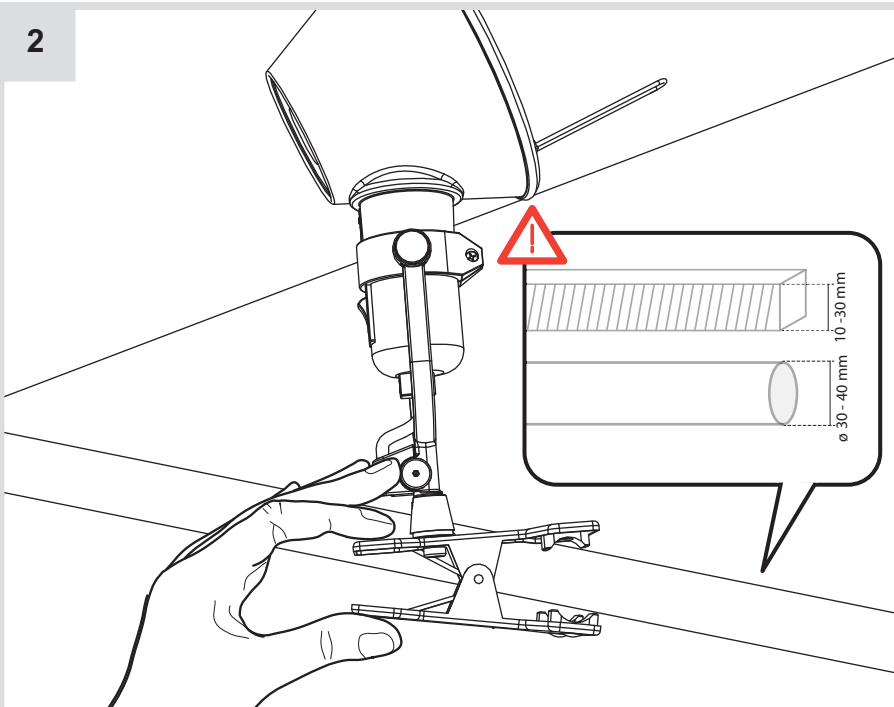

3

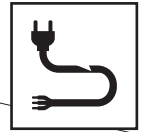
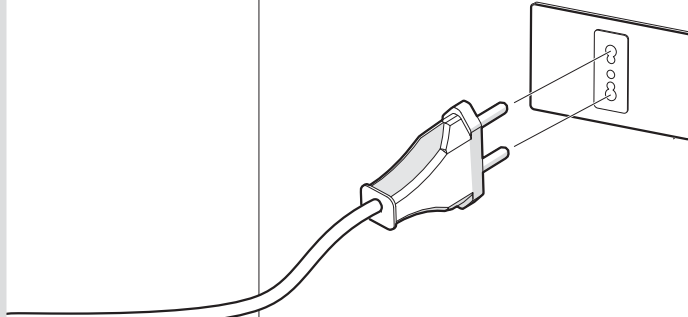

 A0058...

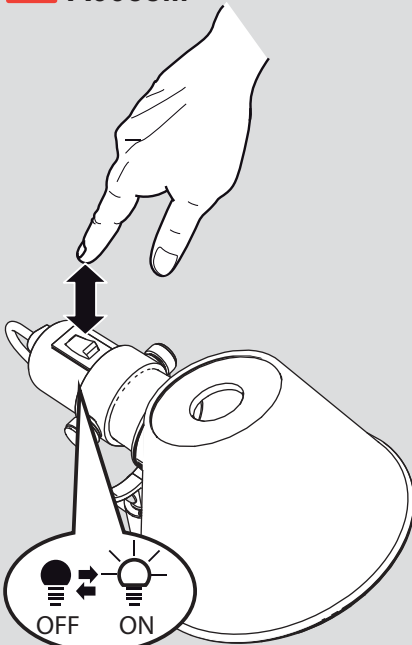

 A0108...

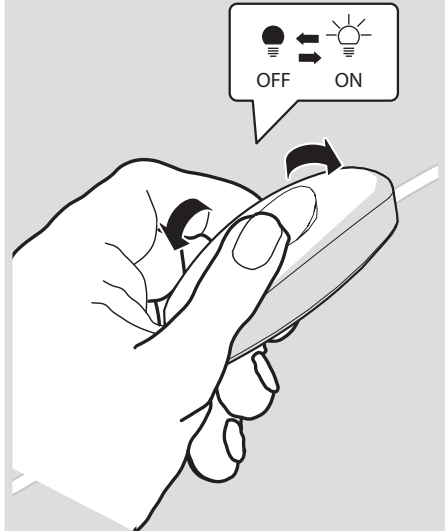



**i**

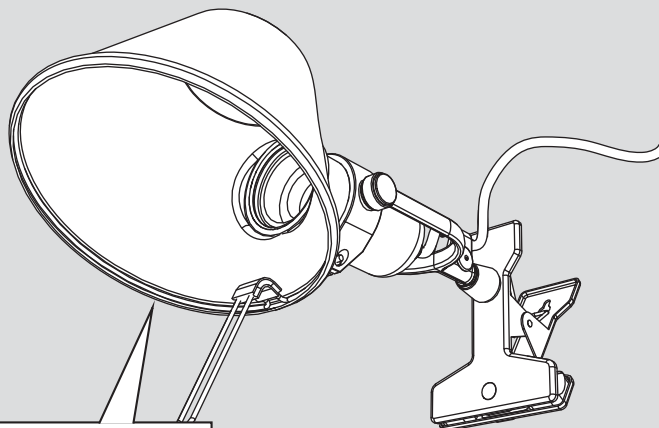

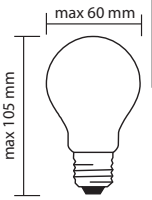
	<p><b>MAX 77W - E27</b></p> <hr/> <p>Halo: HSG - 1300 lm</p> <p>LED: DRAA - 1000 lm</p>
---	---

 **A0058...**

**i**

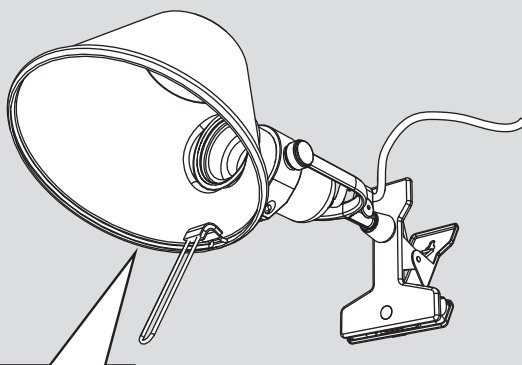

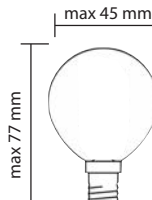
	<p><b>MAX 46W - E14</b></p> <hr/> <p>Halo: HSG - 700 lm</p> <p>LED: DRBP - 400 lm</p>
---	---

 **A0108...**

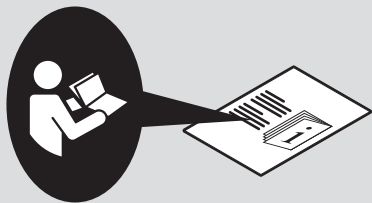



**Artemide®**



**Artemide**

via Bergamo, 18  
20010 Pregnana M.se (MI)  
ITALIA

tel. +39 02 935 181  
fax +39 02 935 90 254  
fax +39 02 935 90 496

[www.artemide.com](http://www.artemide.com)

VAT IT00846890150

cod. Y513000580