

Panthea Portable V2

louis
poulsen

Design Verner Panton

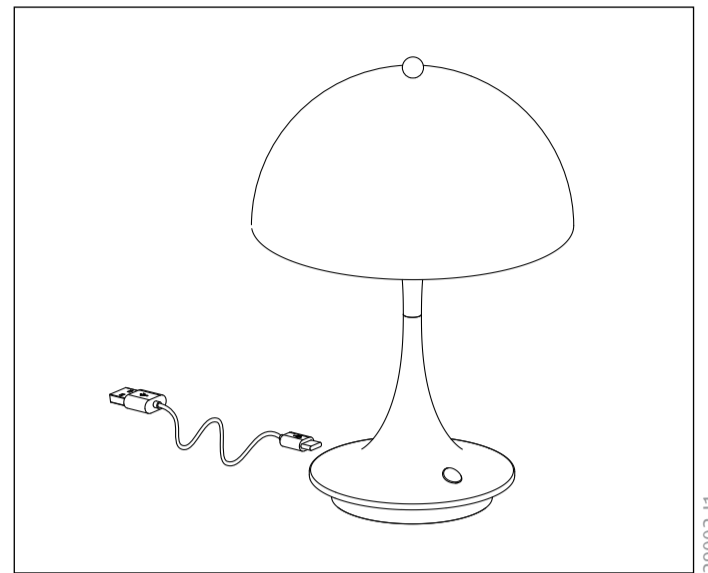
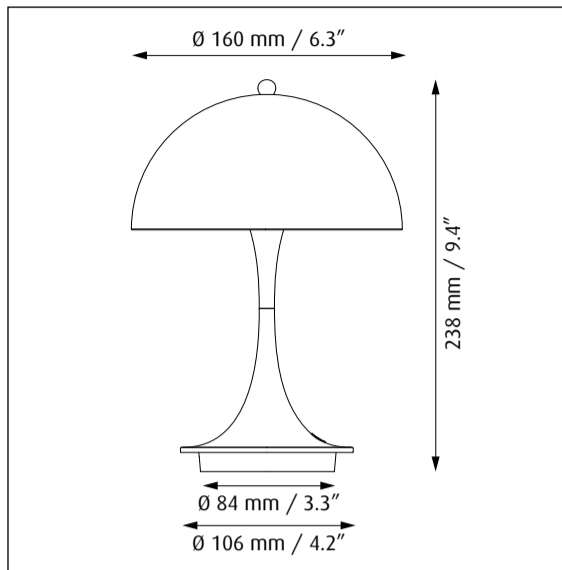

29002-11

Lyskilde Light source Leuchtmittel Ljuskälla Sorgenti luminose Source lumineuse Fuente de luz Valonlähde ランプ	Spænding/frekvens Voltage/frequency Spannung/frequenz Spänning/frekvens Tensione/frequenza Voltage/frequence Tensión/frecuencia Jännite/taajuus 電源電圧 / 周波数	Vægt Weight Gewicht Vikt Peso/ingombro Poids Peso Paino 質量	Isolationsklasse Electric shock protection Schutzklasse Isolationsklass Classe di isolamento Protection au choc électrique Clase de aislamiento Eristysluokka 感電保護クラス	Tæthedsklasse Ingress protection Schutzart Kapslingsklass Grado di protezione Indice de protection Clase de protección Kotelointiluokka IPクラス	
LED 2,5W	DC 5V 1.5A SELV	Max. 0,5 kg/1.1 lbs	Cl. III	IP 44	

DA

Støv aftørres med en tør, blød klud. Fedtpletter og lignende kan fjernes med en blød klud opvredet i lunkent vand (<50° C) tilsat mildt rengøringsmiddel. Brug aldrig rengøringsmidler med slibemiddel eller opløsningsmidler.

EN

Wipe off dust with a dry, soft cloth. Remove greasy spots etc. with a soft cloth dampened in lukewarm water (<50° C) with a mild detergent. Never use detergents containing abrasives and solvents.

DE

Staub bitte mit einem trockenen, weichen Lappen abwischen. Fettflecke und dgl. mit einem feuchten, in lauwarmem Wasser (<50° C) mit mildem Reinigungsmittel ausgewrungenen Lappen entfernen. Niemals Reinigungsmittel mit Schleifmittel oder Lösungsmittel verwenden.

SV

Lampan dammtorkas med en torr, mjuk trasa. Fettfläckar tas bort med ljummet vatten (<50° C) utblandat med mildt rengöringsmedel. Använd aldrig rengöringsmedel som innehåller slipmedel eller lösningsmedel

IT

Pulire la polvere esterna con un panno morbido e asciutto. Rimuovere macchie di grasso ecc. con un panno morbido inumidito in acqua tiepida (<50° C) e con un detergente leggero. Non usare mai detersivi contenenti abrasivi o solventi.

FR

Essuyez la poussière avec un chiffon sec et doux. Enlevez les points de saleté etc. avec un chiffon doux imprégné d'eau claire tiède et de détergent doux. Ne jamais utiliser de détergents contenant des abrasifs et des solvants.

ES

Limpiar con paño seco y suave. Quitar manchas de grasa y otras con paño suave humedecido con agua templada (<50° C) con detergente poco agresivo. Nunca use detergentes que contengan abrasivos y disolventes.

FI

Pyyhi pölyt kuivalla pehmeällä liinalla. Poista rasvatahrat miedolla pesuaineella ja haalealla vedellä (<50° C) kostutetulla pehmeällä liinalla. Älä koskaan käytä liuottimia tai hankausaineita sisältäviä pesuaineita.

JP

ホコリは乾いた柔らかい布で拭き取ってください。塗装部分の油汚れ等は、中性洗剤を溶かしたぬるま湯(50℃以下)に柔らかい布を浸し、よくしぼってから拭き取ってください。シンナー・ベンジン等の揮発物や、つや出し剤・研磨剤は使用しないでください。



DA

Lyskilden i dette armatur må kun udskiftes af producenten eller en uddannet elektriker.



EN

The light source contained in this luminaire shall only be replaced by the manufacturer or a qualified electrician.



DE

Das in dieser Leuchte enthaltene Leuchtmittel sollte nur vom Hersteller oder von einem qualifizierten Elektriker ausgetauscht werden.



SV

Ljuskällan i denna armatur ska endast bytas ut av tillverkaren eller en kvalificerad elektriker.



IT

La sorgente contenuta in questa parte illuminante sarà solo riposizionata dal produttore o da un elettricista esperto.



FR

La source lumineuse de ce luminaire ne peut être remplacée que par le fabricant ou un électricien qualifié.



ES

La sustitución de la fuente de luz que contiene esta luminaria debe ser llevada a cabo exclusivamente por el fabricante o un electricista profesional.



FI

Tämän valaisimen valonlähteen saa vaihtaa ainoastaan valmistaja tai koulutettu sähköasentaja.



JP

この照明器具のLEDは、一般のランプのように取り換えができません。不点の場合は当社にお問い合わせください。

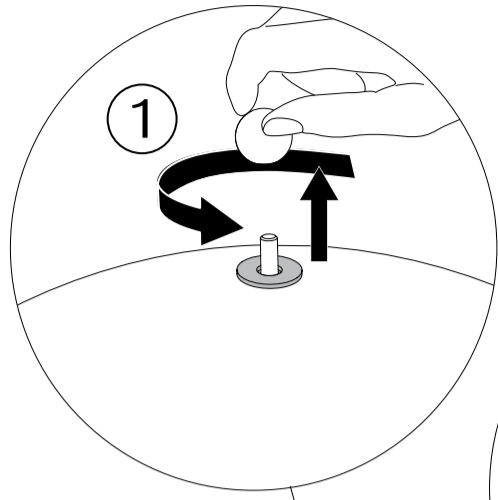
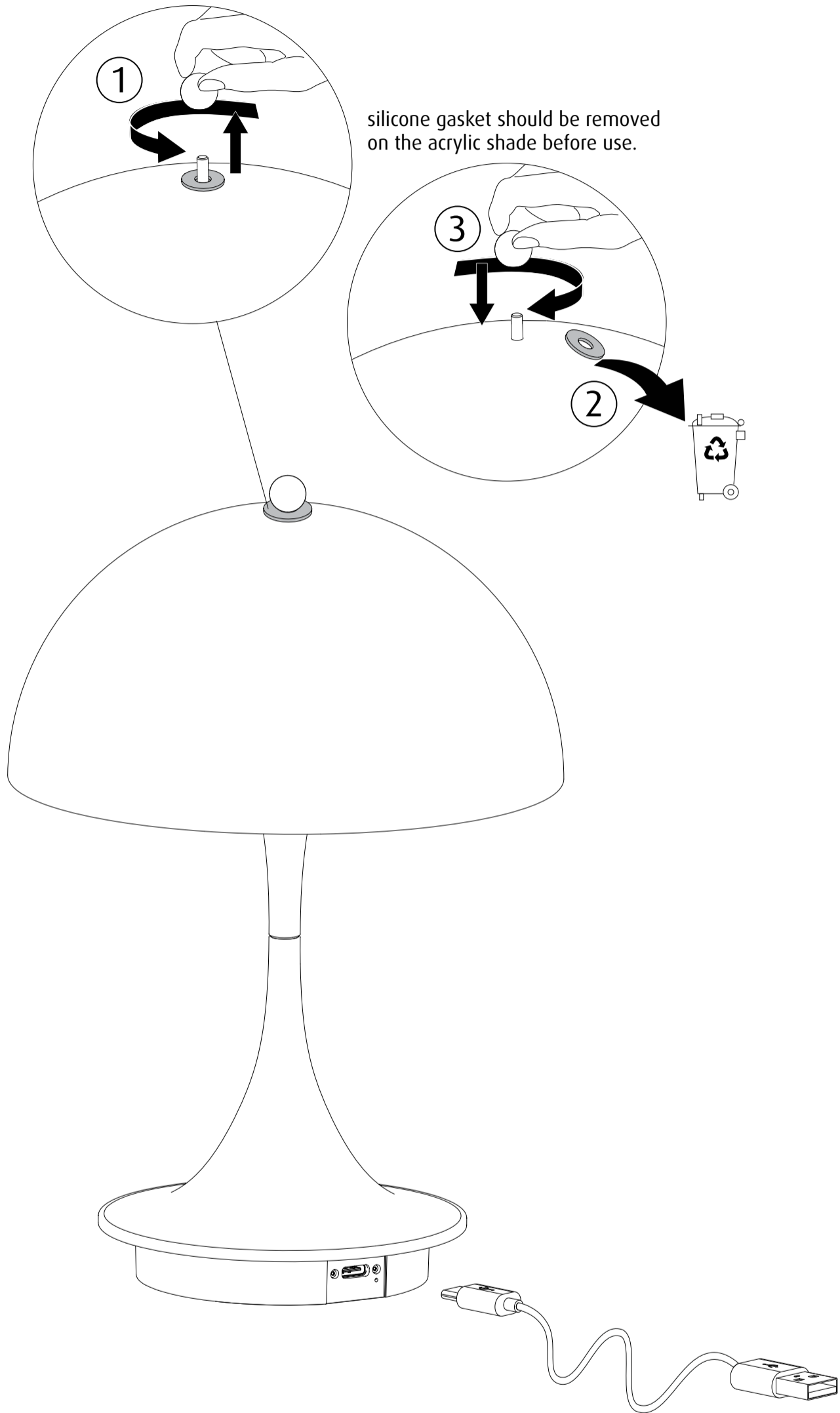
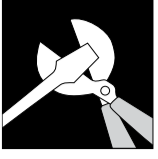

silicone gasket should be removed on the acrylic shade before use.

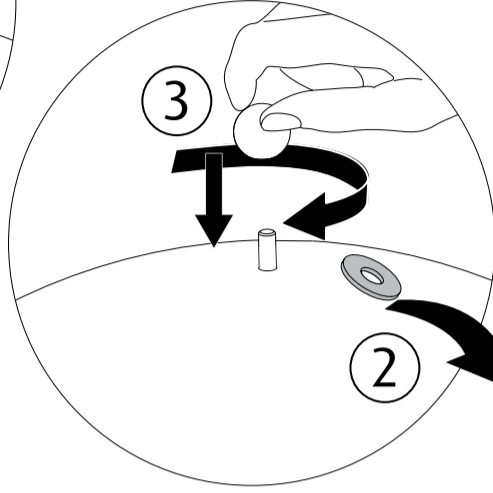

2



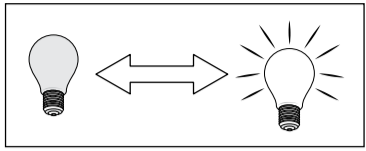
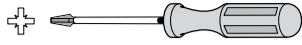

Power on/dimming:

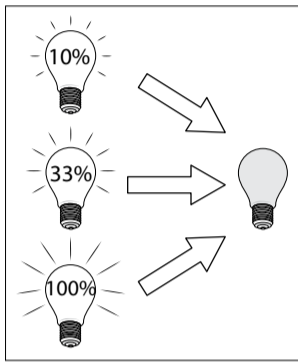
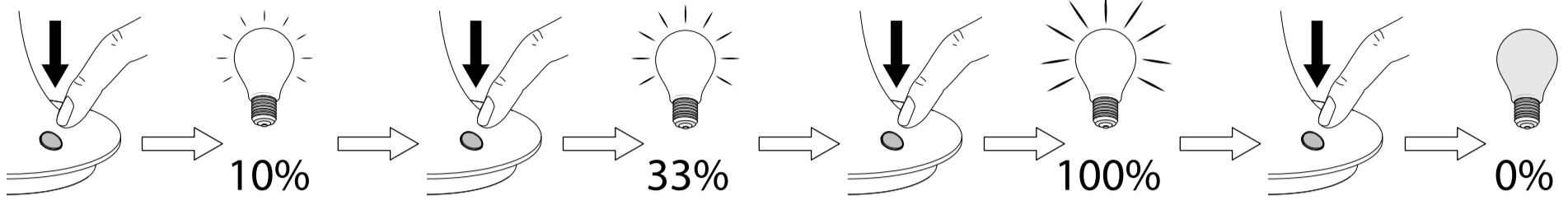

Power off:

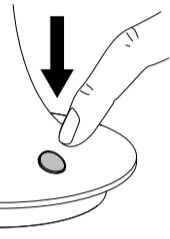

Press and hold 0,5 sec

Lock:

Choose:

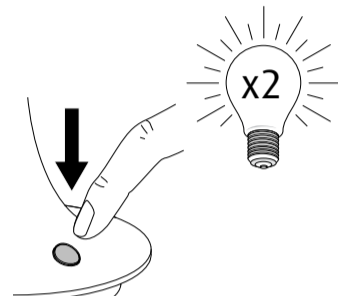

Press and hold >5 sec

Unlock:

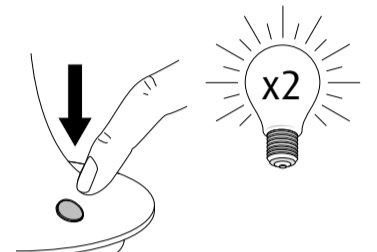

Press and hold >5 sec

Low battery level:

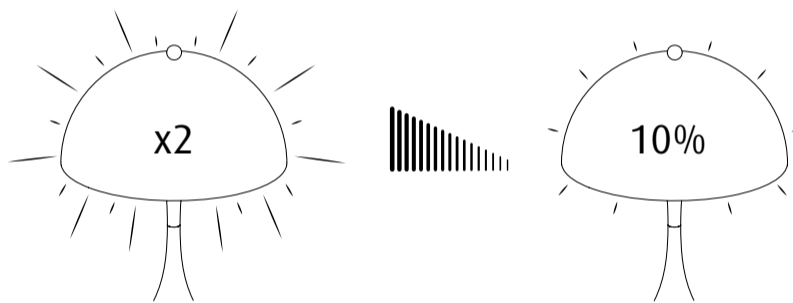

Charging:

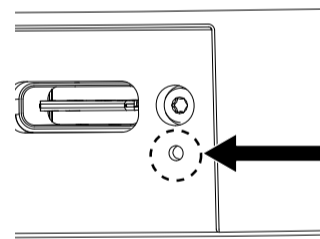
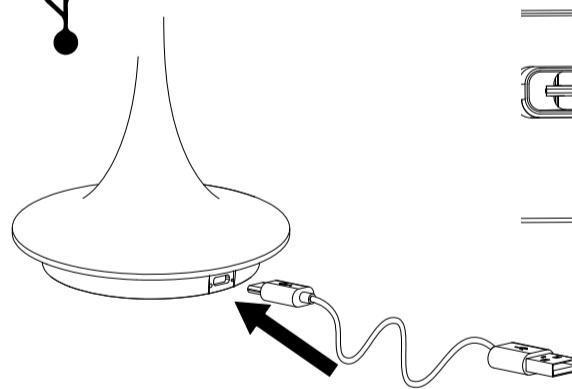
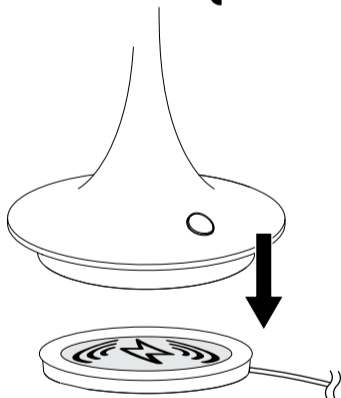

Adapter min. 1.5A

Replace batteries:

